

TIMER MODULE FOR C3 RELAYS

CT3E30L

Time Cube 11 Pin Delay On 20-65V ac/dc

- Provides 3 change-over contacts
- Wide input voltage range, AC/DC
- Multi-time 0.2 s – 30 min.



PRODUCT DESCRIPTION

Example of use

The CT3 Timecube is an electronic timer that is inserted between the plug-in industrial relay and the socket. This combination is a modular complete time relay without additional space requirement. It offers up to three changeover contacts with a variety of signal contacts and power contacts.

The Timecubes are suitable for all 8 pin and 11 pin standard industrial relays of the C2 and C3 series according to IEC 67 and also for relays of other manufacturers.

Relay C3-A30
Time cube CT3
Socket S3-B

SPECIFICATIONS

Nominal Voltage	20-65 V AC/DC
Power Consumption	6 mA
Response time	AC-80 ms / DC-50 ms
Leakage current	≤ 0.3 mA
IP Class	IP40
Material	Lexan
Temperature range from	-25 °C
Temperature range bearing, from	-40 °C
Temperature range bearing, to	70 °C

Temperature range to	60 °C
Weight	35 g
Recovery Time	200 ms
Approvals	CE, CSA, RoHS, UL
Time Range	0,2 s - 30 min

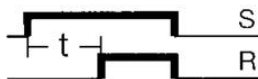
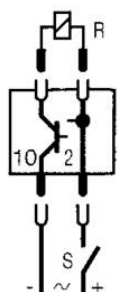

Range

- 0,2 - 3 s
- 2 - 30 s
- 0,2 - 3 min
- 2 - 30 min

DIP switch

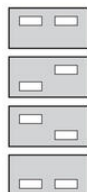

Time

Adjusting knob
1 ... 10

Relä

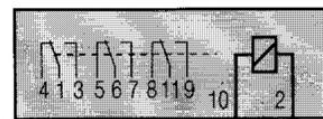

Tidkub

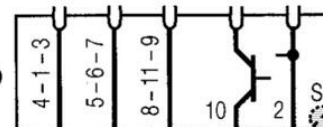

Socket

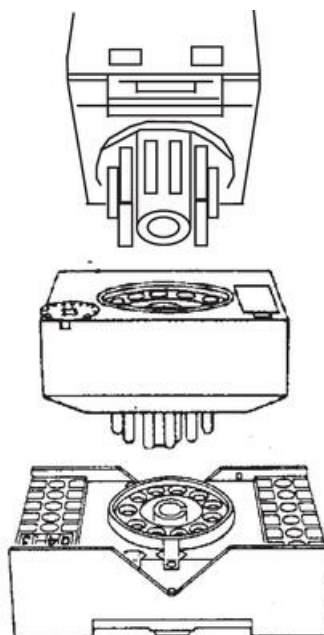
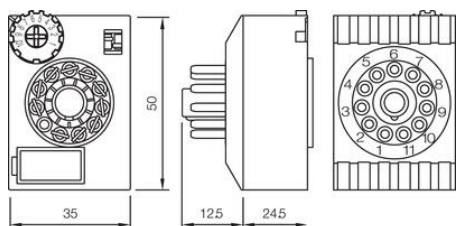
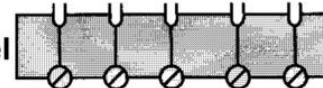

Range

- 0,2 - 3 s
- 2 - 30 s
- 0,2 - 3 min
- 2 - 30 min

DIP switch



Time

Adjusting knob
1 ... 10

