

**POWER SUPPLY 3-PHASE, 36 V DC
DIMENSION Q SERIES**

QT20.361
POWER SUPPLY 36VDC 480W 13A

- Output current of 13.3 A
- Up to 94.8% efficiency
- High short-circuit currents
- Several protective filter
- Maximum performance



PRODUCT DESCRIPTION

Puls Dimension Q is a series of power supplies with very small construction dimensions and many technical advantages. The unit has low inrush current (even during warm start), active PFC, which provides a power factor close to one, extended temperature range, as well as active protection against mains transients. Furthermore, there is a relay output (DC OK) that falls when the output voltage deviates more than 10% from the set value. The bonus power provides 50% extra reserve with retained voltage which is an advantage when connected loads have high starting currents. The unit also provides a high short-circuit current that simplifies tripping of secondary fuses. Both the bonus power and short-circuit current is limited to 4 seconds to avoid constant overloading of the power supply and wiring. High efficiency for long life and low temperature. The power supply can be connected for two-phase operation Within up to +40°C. At higher temperatures, the load current is reduced.

Bonus power

The power supply has bonus power that enables high power outlet with retained 36 V DC for 4 seconds, which is a major advantage when connected loads have high starting currents, such as the case with motors. How often you can use the bonus effect depends on the application. With the following diagram and formula, the repeat time can be calculated for each application. The bonus power is available as soon as the power supply is started and directly after a short circuit.

Bonus power	Operating charcterisitcs
Po	Nominal load current
Ppeak	Peak current
To	Time between bonus power
Tpeak	Peak current in time
Operating cycle	Tpeak / (Tpeak + To)
To	Tpeak - (operating cycle * Tpeak) / operating cycle

E.g. Nominal load current (Po) is 6.6 A, Po = 50% of In. Peak current (Ppeak) is 16A = 120%. Peak time is 3 seconds. Draw a vertical line at 120% of duty cycle, where the line crosses the Po = 50% horisontel draw a line to the duty cycle value. In this case, the value is about 0.68. $3 - (3 \times 0,68) / 0.68 = 1.41$. In this example, one can repeat the bonus effect with a gap of 1.41 seconds.

SPECIFICATIONS

Input voltage range	Wide-range
Number of phases	3
Input voltage AC	380-480 V
Input voltage ac min	323 V AC
Input voltage ac max	552 V AC
Inrush current at 400 V ac typical	3 A
Power Factor at 400 V AC, full load. Typical	0.94
Supply Frequency	50-60 ±6 %
Power consumption at 400 V ac	0.79 A
Type Power Supply	AC-DC

Output voltage	36 V DC
Output voltage min	36 V DC
Output voltage max	42 V DC
Output Current	13.3 A
Effect	480 W
Power Reduction Of 60 To 70 ° C	12 W/°C
Ripple. max	100 mV pp
Temperature Range Without Derating From	-25 °C
Temperature Range Without Derating To	60 °C

Efficiency At 400 V AC. Typical	94 %
Efficiency At 400 V AC, full load. Typical	94.8 %
Lifetime at 400 V ac, full load and +40 ° C	51000 h
MTBF (IEC 61709) 400 V ac, max loan, +40 °C	690000 h

Width	65 mm
Height	124 mm
Depth	127 mm
Weight	0.87 kg

Clamp type	Spring-clamp
-------------------	--------------

Series	Dimension Q
Approvals	CB, CE, CSA US, cRUus, cULus, GL

DC relay output	Yes
Material Protection	Aluminium
Hold-up time at 400 V AC, full load. Typical.	22 ms
IP Class	IP20
Active Transient	Yes

Fig. 6-1 Output voltage vs. output current, typ.

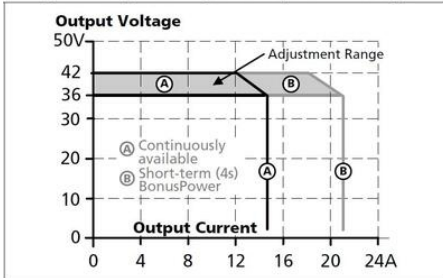

Fig. 15-1 Output current vs. ambient temp.

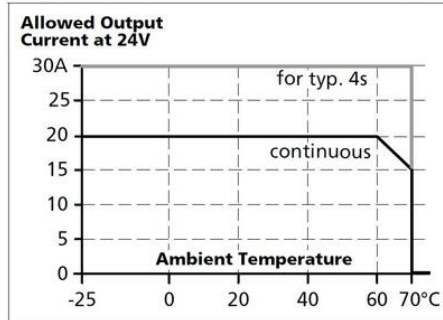

Fig. 6-2 Bonus time vs. output power

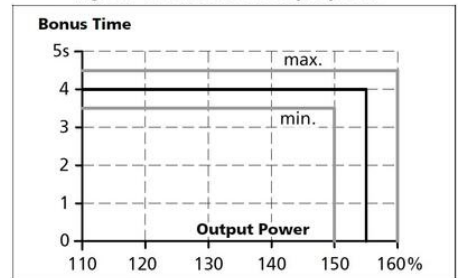

Fig. 9-1 Efficiency vs. output current at 36V, typ.

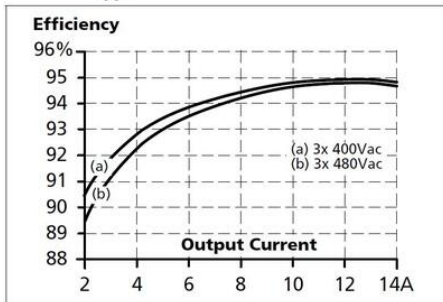
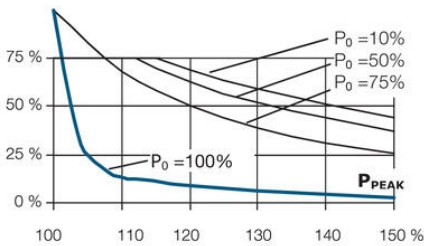
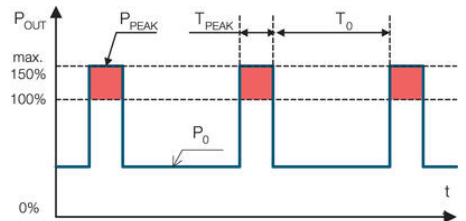
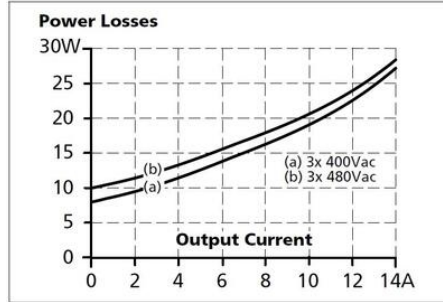

Fig. 9-2 Losses vs. output current at 36V, typ.



Maximal wire length¹⁾ for a fast (magnetic) tripping:

	0.75mm ²	1.0mm ²	1.5mm ²	2.5mm ²
C-2A	69m	86m	123m	200m
C-3A	21m	28m	39m	63m
C-4A	9m	13m	18m	29m
B-6A	11m	16m	24m	33m
B-10A	1m	1m	1m	1m

Fig. 13-1 Front side



Fig. 20-1 Front view

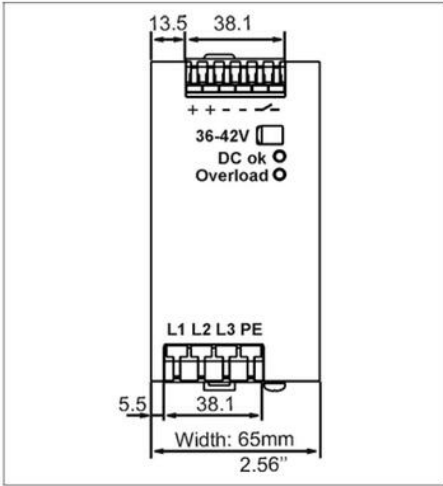

Side view

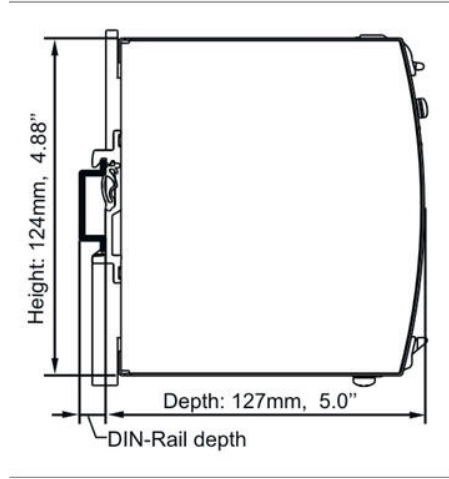

Fig. 6-1 Output voltage vs. output current, typ.

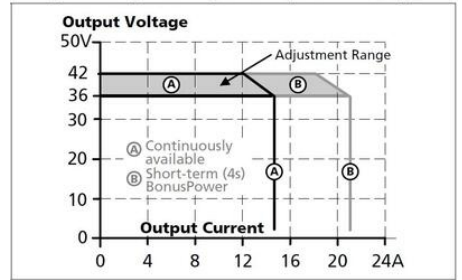

Fig. 15-1 Output current vs. ambient temp.

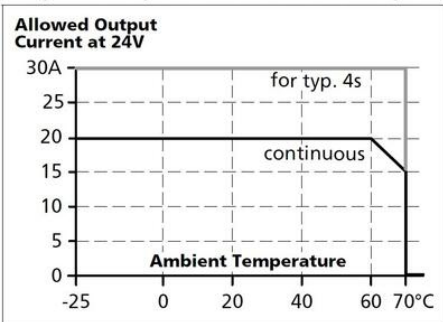

Fig. 6-2 Bonus time vs. output power

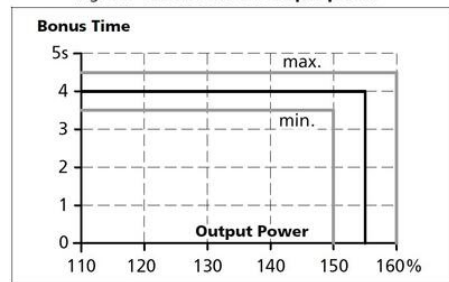

Fig. 9-1 Efficiency vs. output current at 36V, typ.

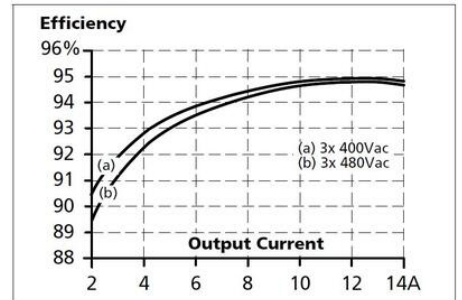
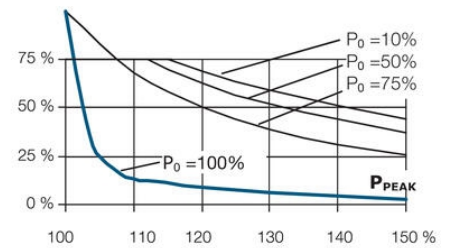
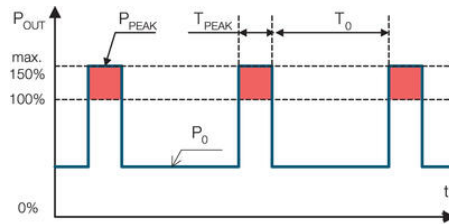
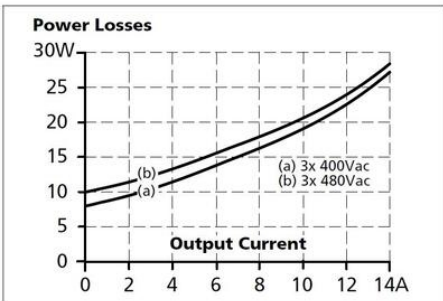

Fig. 9-2 Losses vs. output current at 36V, typ.



Maximal wire length¹⁾ for a fast (magnetic) tripping:

	0.75mm ²	1.0mm ²	1.5mm ²	2.5mm ²
C-2A	69m	86m	123m	200m
C-3A	21m	28m	39m	63m
C-4A	9m	13m	18m	29m
B-6A	11m	16m	24m	33m
B-10A	1m	1m	1m	1m

Fig. 13-1 Front side

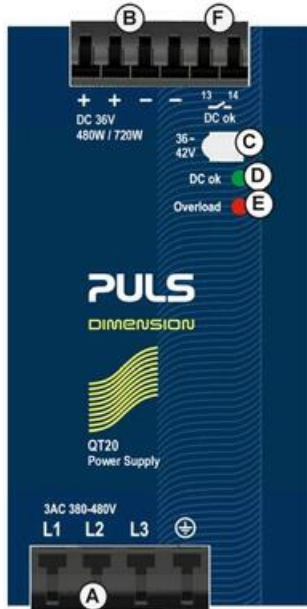
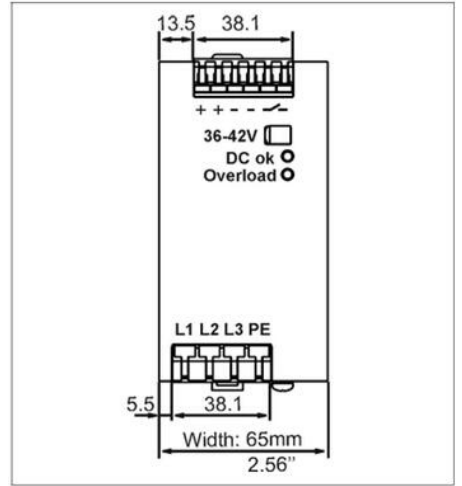

Fig. 20-1 Front view



Side view

